

Level sensing relative and absolute pressure transmitter type 712

Pressure range
0 ... 0.3 - 3 bar



The level sensing pressure transmitter Type 712 is manufactured using an relative or absolute pressure measuring cell with an adjusted and amplified sensor signal and is available with various cable lengths from 2 to 30 meters. The Type 712 offers Ex protection as well as versions with integrated temperature measurement.

In addition to voltage and current outputs the Type 712 is available with ratiometric outputs.

- suitable for drinking water
- intrinsically safe execution with voltage- and current output
- suitable for fitting in 1-inch pipe
- with integrated temperature measurement

Technical overview

Pressure range				
Relative		0.0 ... 0.3	– 2.5 bar	
Absolute		0.8 ... 1.4	– 3.0 bar	
Operating conditions				
Medium		Fuel oil, ultra-light ¹⁾	SN 181 160-2	
		Fuel oil, heavy ¹⁾	SN 181 160-2	
		Diesel oil ¹⁾		
		Benzine ¹⁾		
		Drinking water (with EPDM O-ring)		
Temperature		Medium and ambient ²⁾	-20 ... +80 °C	
		Storage	-40 ... +80 °C	
Overload		3x fs; max. 3 bar at 0.3 bar version		
Materials in contact with medium				
Case		Stainless steel 1.4404 / AISI 316L		
Sensor		Ceramic Al ₂ O ₃		
Cable		PE-HD		
Protection cover		PPE		
Sealing material		FPM, EPDM (for drinking water)		
Electrical overview				
	Output	Power supply	Load	Current consumption
2 wire	4 ... 20 mA	10 ... 30 VDC	< $\frac{\text{Power supply} - 7 \text{ V}}{0.02 \text{ A}}$ [Ohm]	< 20 mA
3 wire	0 ... 10 V	12 ... 30 VDC	>10 kOhm / < 100 nF	< 5 mA
4 wire (with temperature)	ration. 10 ... 90%	5 VDC ±10%	> 5 kOhm / < 100 nF	< 3 mA
Polarity reversal protection	Short circuit proof and protected against polarity reversal.			< 3 mA
Temperature output				> 1 MOhm
Dynamic response				
Response time				< 2 ms
Protection standard				
IP 68				
Runtime				
Time starts at the moment of application of minimal supply voltage				< 10 ms
Electrical connection				
Cable PE-HD				length 2, 5, 10, 15, 20, 30 m
Test / Admissions				
Electromagnetic compatibility				CE-conform acc. to EN 61326-2-3
UL				ANSI/UL 61010-1 acc. to E325110
Drinking water approval				ACS
Drinking water verification certificate for plastic parts				KTW
				W270
				WRAS
Ex-protection				
IECEX SEV 12.006				Ex ia IIC T4 Ga
SEV 12 ATEX 0138				II 1 G Ex ia IIC T4 Ga
Weight				
Without cable				~ 200 g
Packaging				
Single packaging				

Accuracy

Standard

Parameter	Unit	
Max. deviation ³⁾ at 25 °C	% fs	± 0.8
Resolution ⁴⁾	% fs	0.1
Thermal characteristic ^{5), 6)}	% fs/10K	± 0.2
Long term stability acc. IEC EN 60770-1 max.	% fs	± 0.25

Higher accuracy (only with ratiometric execution and pressure range ≥ 1 bar)

Parameter	Unit	
Max. deviation at compensated temperature range ³⁾ at -10 ... +60 °C	% fs	± 0.5
Resolution	% fs	0.1
Long term stability acc. IEC EN 60770-1 max.	% fs	± 0.25

¹⁾ Ex-protection to attention!
⁴⁾ pressure range 0.3 bar < 0.2 % fs

²⁾ non-congealing media
⁵⁾ at -20 ... +80 °C

³⁾ incl. zero point, full scale, linearity, hysteresis and repeatability
⁶⁾ 0.3 bar-type with output 4 ... 20 mA = ±0.5% fs/10K

				1	2	3	4	5	6	7	8	9	10		
Order code selection table				712. X X X X X X X X X X											
Pressure mode	Absolute			8											
	Relative			9											
	Absolute with higher accuracy			C				1,2							
	Relative with higher accuracy			D				1,2							
Pressure range ¹⁾	0.0 ... 0.3 bar		relative pressure	Pmax. 4.5 bar	9	1	3								
	0.0 ... 1.0 bar		relative pressure	4.5 bar	9,D	1	1								
	0.0 ... 1.6 bar		relative pressure	6.0 bar	9,D	1	2								
	0.0 ... 2.5 bar		relative pressure	9.0 bar	9,D	1	4								
	0.8 ... 1.4 bar		absolute pressure	4.5 bar	Max measurable level (for water depending on the locations weather)		3.5 ... 6.7 mWs	8	1	1					
	0.8 ... 2.0 bar		absolute pressure	6.0 bar	9.6 ... 12.8 mWs	8,C	1	2							
	0.8 ... 3.0 bar		absolute pressure	9.0 bar	20.0 ... 23.0 mWs	8,C	1	4							
▲ Full scale signal at these pressures				①											
① P _{BARG} = 1060 mbar (high pressure on sea level)															
② P _{BARG} = 740 mbar (low pressure at 2000 meters above sea level)															
Sealing material	FPM Fluoro-elastomer							0							
	EPDM Ethylene propylene (for drinking water)							1							
Output / power supply	4 ... 20 mA		10 ... 30 VDC						0						
	ration. 10 ... 90%		5 VDC ±10%						1						
	ration. 10 ... 90%		5 VDC ±10% (with temperature)						2						
	0 ... 10 V		12 ... 30 VDC						3					0	
Electrical connection ²⁾	Cable	2 m							0						
		5 m							1						
		10 m								2					
		15 m								3					
		20 m								4					
		30 m								5					
Protection cover	without protection cover										2	0			
	with protection cover										2	1			
Ex-protection	without ex-protection												0		
	with ex-protection												4		
Pressure range variation (optional)	Indicate W and state range on order (e.g.: W0... + 2bar/OUT0...10V)													W	

Dimensions in mm / Electrical connections

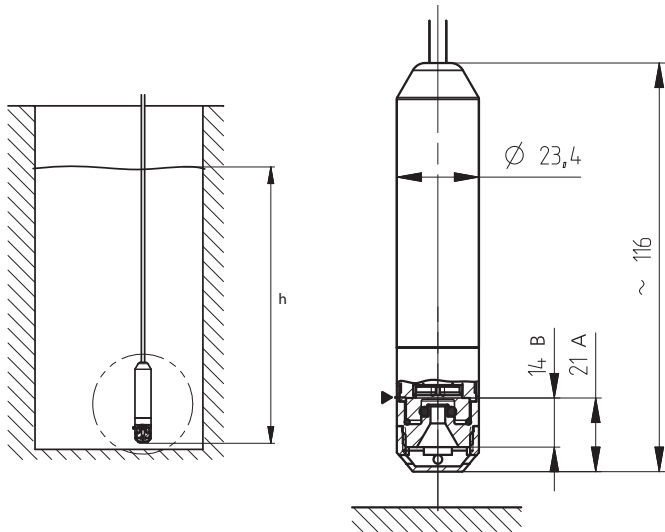

- h - Fluid level
- ▶ - Measurement reference height
- A - Distance from protection cover to the position of measuring diaphragm
- B - distance from beginning of thread to the position of measuring diaphragm (versions without protection cover)

4 ... 20 mA

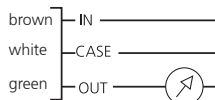

ration. 10 ... 90%, 0 ... 10 V

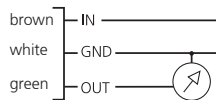

ration. 10 ... 90% with temperature

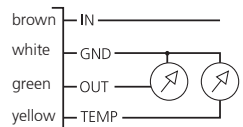

Device design with explosion protection: 4 ... 20 mA
The grounding connection is conductively connected to the level transmitter housing. The ground conductor of level transmitter must be connected to the equipotential bonding system of the plant.

Device design with explosion protection: ration. 10 ... 90%
The electronic GND is connected with a 1MΩ resistor to the level transmitter housing. The GND conductor of level transmitter must be connected to the equipotential bonding system of the plant.

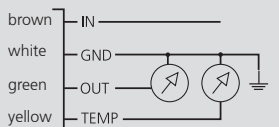
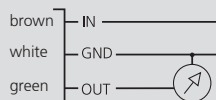

¹⁾ Other pressure range on request

²⁾ Other cable length on request

	Order number
Cable hanger	118026
Connection box	118027
Test adapter	118028
Protection cover (pack of 10)	118067
Humidity protection element (pack of 10)	118068
Additional weight	118093
Calibration certificate	104551

Connection box

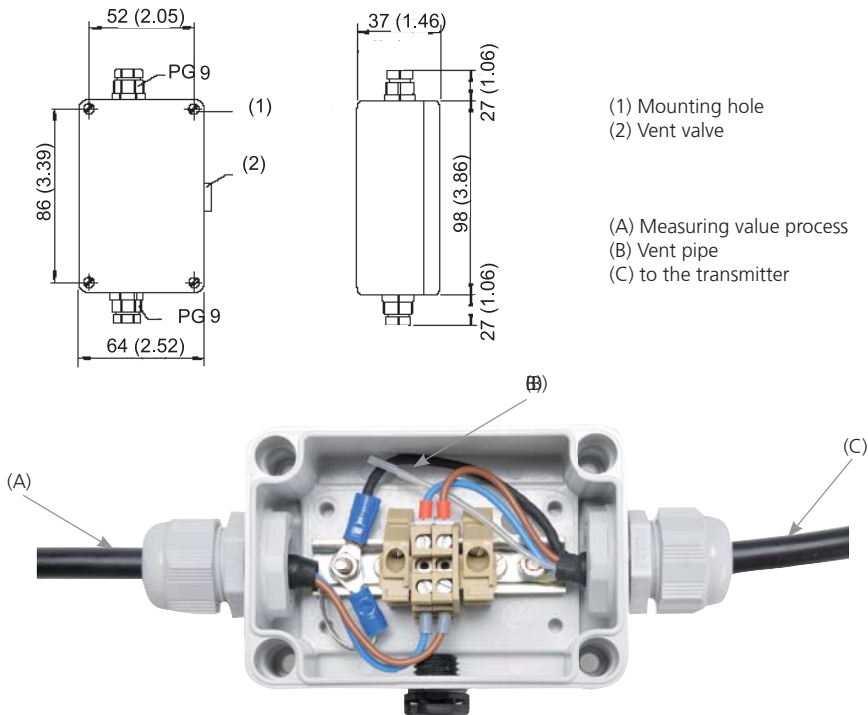

Additional weight
~200 g

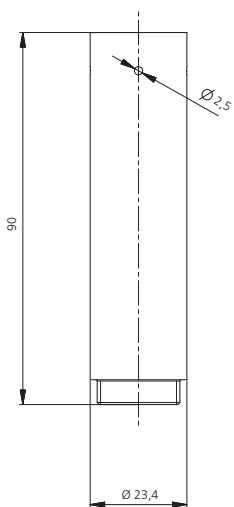

Protection cover

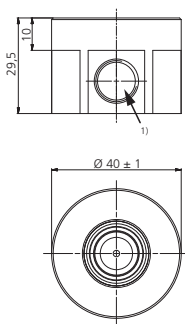

1) Inside thread Iso 228/1-G 1/4 A

Cable hanger

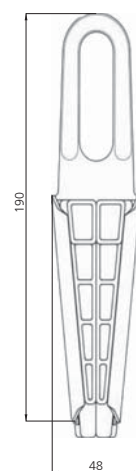

hot-dip galvanized steel –
PA6 glass fibre reinforced

Cable Ø 4.5 ... 6.5

Calculation of level

General level with relative pressure sensor:
$$h = \frac{\Delta p}{\rho \cdot g}$$

General level with absolute pressure sensor:
$$h = \frac{P_{TS} - P_{Baro}}{\rho \cdot g}$$

which
$$P_{TS} = \frac{U_{TS} - U_{TS_NP}}{U_{TS_EW} - U_{TS_NP}} \cdot (P_{TS_EW} - P_{TS_NP}) + P_{TS_NP}$$

and
$$P_{Baro} = \frac{U_{Baro} - U_{Baro_NP}}{U_{Baro_EW} - U_{Baro_NP}} \cdot (P_{Baro_EW} - P_{Baro_NP}) + P_{Baro_NP}$$
 Using a second level sensor as barometric air pressure sensor

For level sensor with current output use nominal signal values for I_{TS} ... instead of variables U_{TS} ... (resp. I_{Baro} ... instead of U_{Baro} ...)

Simplification of formula for level sensor with ratiometric output:

$$P_{TS} = \frac{U_{TS} - 0.1 \cdot U_{IN}}{0.8 \cdot U_{IN}} \cdot (P_{TS_EW} - P_{TS_NP}) + P_{TS_NP}$$

$$P_{Baro} = \frac{U_{Baro} - 0.1 \cdot U_{IN}}{0.8 \cdot U_{IN}} \cdot (P_{Baro_EW} - P_{Baro_NP}) + P_{Baro_NP}$$
 Using a second level sensor as barometric air pressure sensor

Legend:

h	level [m]	ρ	density of media [kg/m ³]
		g	acceleration of fall 9.80665 [m/s ²]
Δp	measured relative pressure [Pa]	U_{TS}	signal on level sensor output [V or mA]
P_{TS}	measured pressure of level sensor [Pa]	U_{BARO}	Signal on barometer output [V or mA]
P_{BARO}	measured pressure of barometer [Pa]		
P_{TS_NP}	minimal nominal pressure of level sensor [Pa]	U_{TS_NP}	minimal nominal signal of level sensor [V or mA]
P_{TS_EW}	maximum nominal pressure of level sensor [Pa]	U_{TS_EW}	maximum nominal signal of level sensor [V or mA]
P_{BARO_NP}	minimal nominal pressure of barometer [Pa]	U_{BARO_NP}	minimal nominal signal of barometer [V or mA]
P_{BARO_EW}	maximum nominal pressure of barometer [Pa]	U_{BARO_EW}	maximum nominal signal of barometer [V or mA]

Specification temperature output

$$T_{TEMP} = T_0 + 1 \left/ \left(a + b \cdot \ln \left(R \cdot \left[\frac{U_{IN}}{OUT T} - 1 \right] \right) + c \cdot \ln \left(R \cdot \left[\frac{U_{IN}}{OUT T} - 1 \right] \right)^3 \right) \right. T_{TEMP}$$

Temperature NTC [°C]
-273.15 [°C]

OUT T Voltage NTC [V]
R 20'000 [Ω]
 U_{IN} 4.5 ... 5.5 [V]

a = 0.001204001
b = 0.000208775
c = 0.000000294

$T_{TEMP} = f(OUT T)$

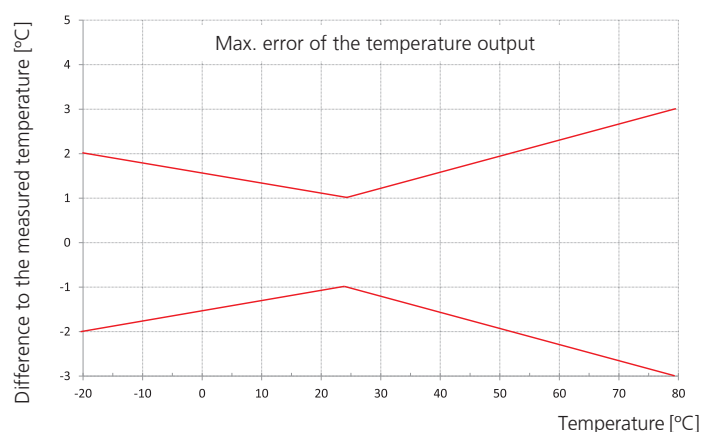
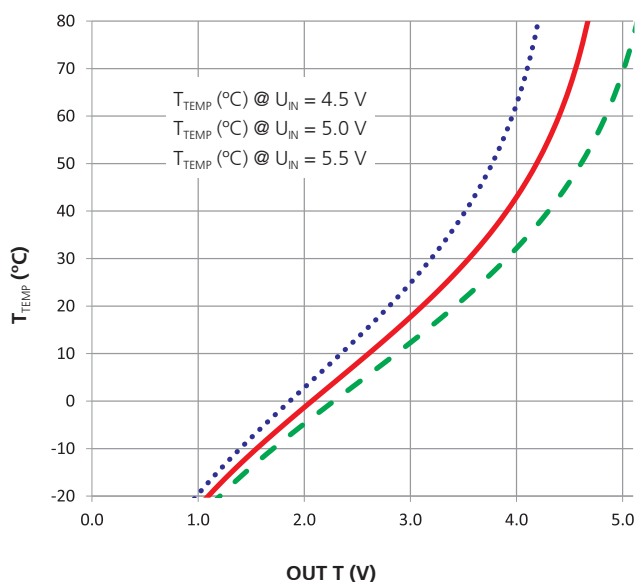

Huba Control AG
Headquarters

Industriestrasse 17
5436 Würenlos
Telefon +41 (0) 56 436 82 00
Telefax +41 (0) 56 436 82 82
info.ch@hubacontrol.com

Huba Control AG
Niederlassung Deutschland

Schlattgrabenstrasse 24
72141 Walddorfhäslach
Telefon +49 (0) 7127 23 93 00
Telefax +49 (0) 7127 23 93 20
info.de@hubacontrol.com

Huba Control SA
Succursale France

Rue Lavoisier
Technopôle Forbach-Sud
57602 Forbach Cedex
Téléphone +33 (0) 387 847 300
Télécopieur +33 (0) 387 847 301
info.fr@hubacontrol.com

Huba Control AG
Vestiging Nederland

Hamseweg 20A
3828 AD Hoogland
Telefoon +31 (0) 33 433 03 66
Telefax +31 (0) 33 433 03 77
info.nl@hubacontrol.com

Huba Control AG
Branch Office United Kingdom

Unit 13 Berkshire House
County Park Business Centre
Shrivenham Road
Swindon Wiltshire SN1 2NR
Phone +44 (0) 1993 776667
Fax +44 (0) 1993 776671
info.uk@hubacontrol.com